

TELESKOPOWY SYSTEM PRZESUWNY SM-L

Systemy teleskopowe SM-L to wygodne rozwiązanie do zabudowy przestrzeni wewnętrznych i zewnętrznych. Idealnie sprawdzi się do wydzielenia szerokich przejść - do 10 skrzydeł o szerokości do 1200mm. System występuje w dwóch rozwiązaniach technicznych - z pojedynczymi i podwójnymi wózkami jezdny. Możliwość zastosowania widocznej - odwadniającej szyny jezdnej jak również szyny ukrytej (bezprogowa) pozwala na zastosowanie systemu zarówno we wnętrzach jak i na zewnątrz. Duża wygoda obsługi dzięki zastosowaniu skrzydeł teleskopowych - przesuwając pierwsze skrzydło przesuwamy kolejne aż do całkowitego złożenia systemu. Systemy SM-L świetnie sprawdzą się w funkcji zabudowy tarasu o maksymalnej wysokości do 3108mm. System umożliwia zastosowanie szkła 8 lub 10mm dla serii SM-L400 i 10 lub 12mm dla SM-L500 i wadze odpowiednio 60 i 100kg na skrzydło. Wysokiej jakości komponenty gwarantują bezawaryjne działanie.

TELESKOPOWY SYSTEM PRZESUWNY SM-L 400

SM-L400-8

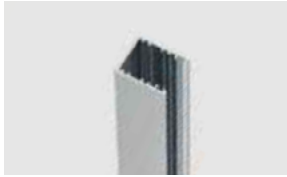

SM-L400-10

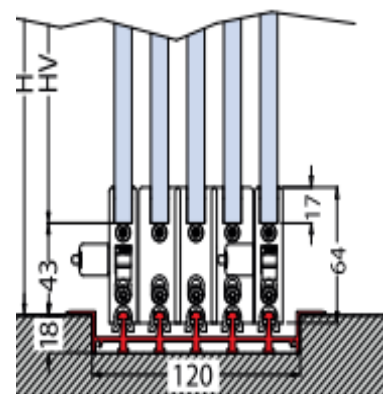
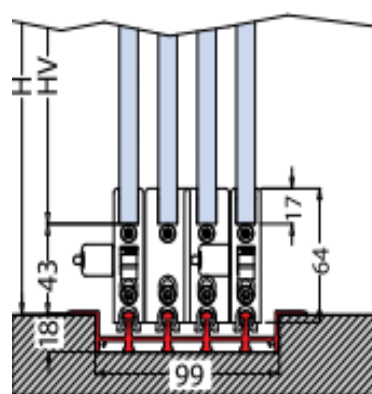
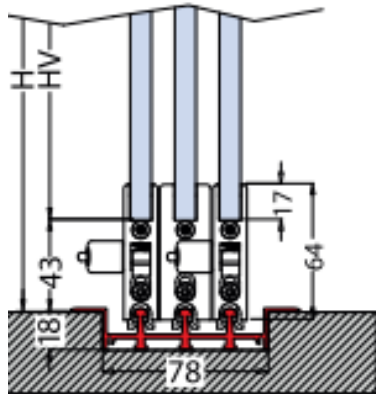
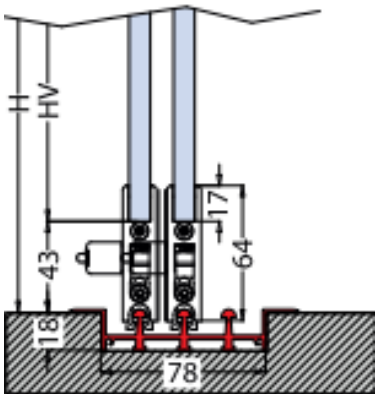
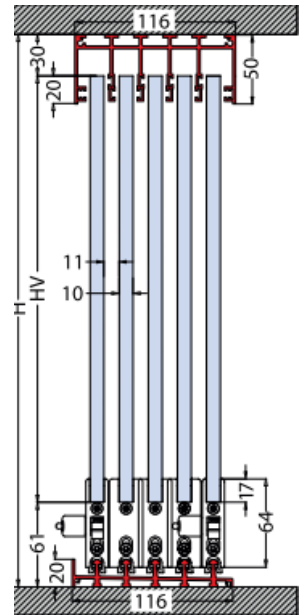
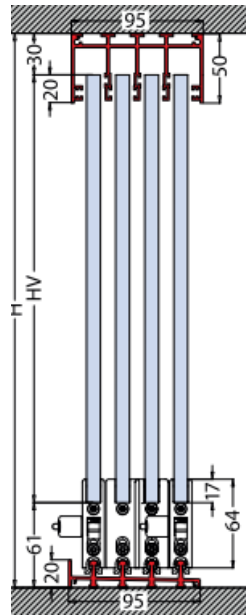
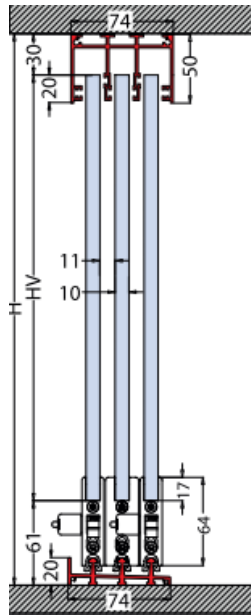
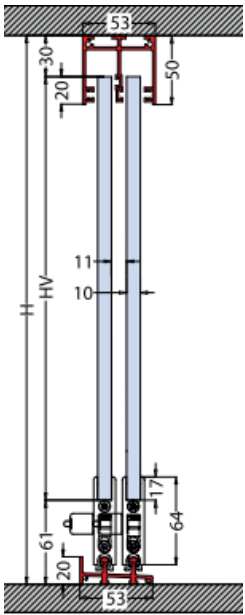
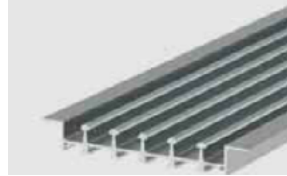
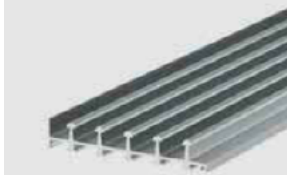

set 2

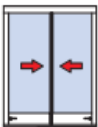

set 3

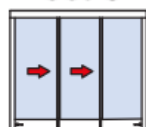

set 4

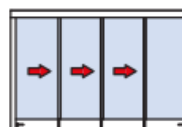

set 5

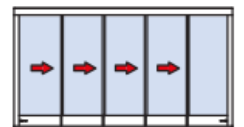

set 2 + set 2



set 3 + set 3

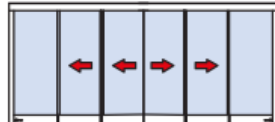

set 4 + set 4

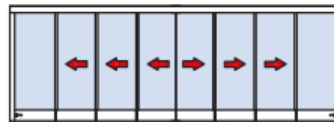

set 5 + set 5



TELESKOPOWY SYSTEM PRZESUWNY SM-L 500

SM-L500-10

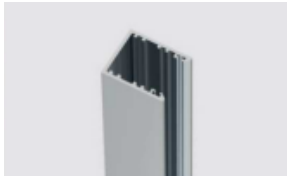

SM-L500-12

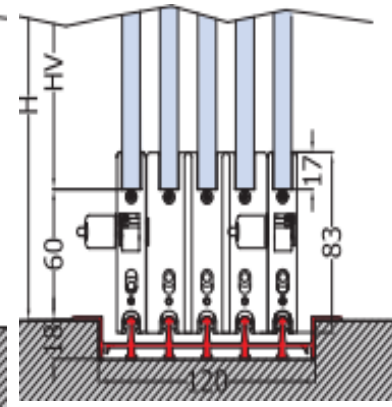
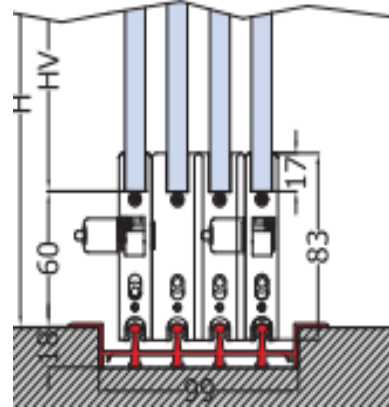
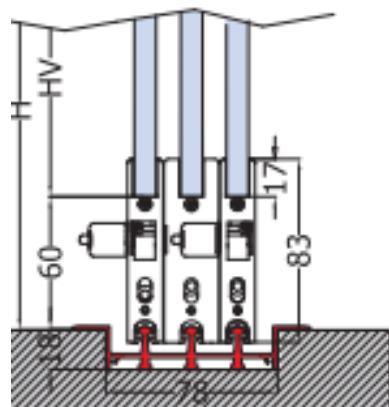
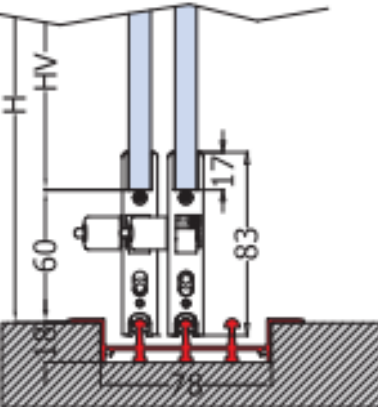
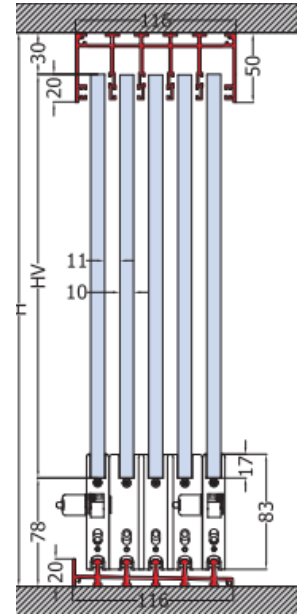
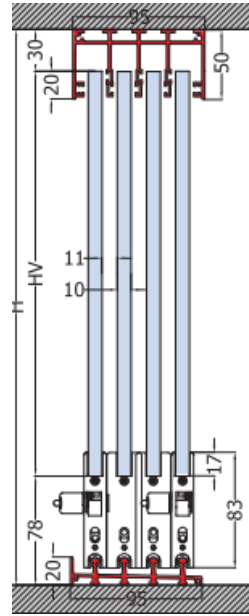
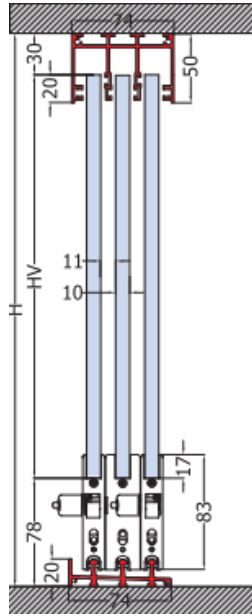
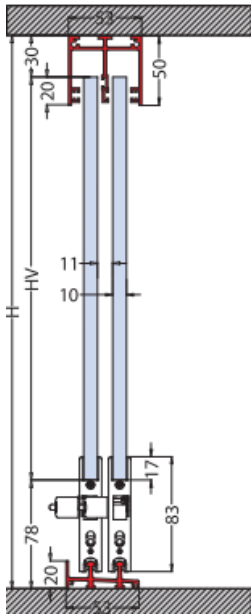
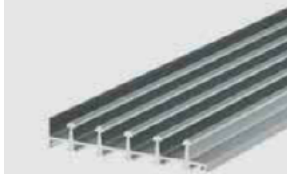

set 2

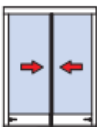

set 3

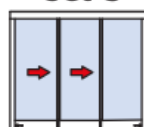

set 4



set 5

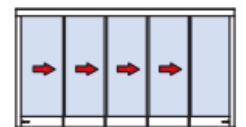

set 2 + set 2



set 3 + set 3

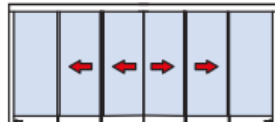

set 4 + set 4

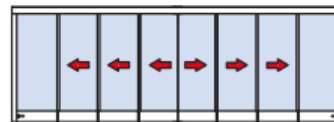

set 5 + set 5

